

LAR.181

## Traviata



*Descrizione: / Description:*

*Apparecchio a parete da esterno con riflettore in rame anticato, diffusore in vetro temprato trasparente e braccio in ottone anticato.*

*/ Outdoor wall lamp with aged copper reflector, clear tempered clear glass and aged brass arm.*

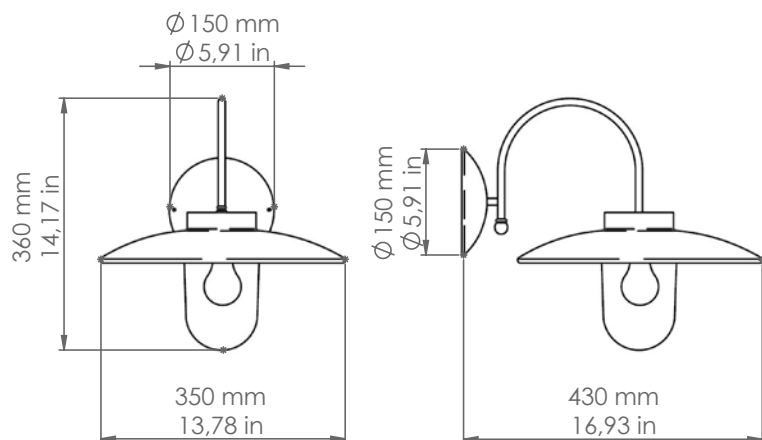

## LAR.181

DATI TECNICI: / TECHNICAL DATA:

CE IP43

SORGENTE LUMINOSA: / LIGHT SOURCE:

15W LED  
230V - 50Hz  
E27

LAMPADINA NON INCLUSA  
/ LIGHT BULB NOT INCLUDED

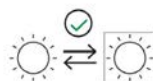

Sorgente luminosa sostituibile dall'utente finale  
/ Replaceable light source by an end-user

VOLUME [M³]: 0,08

PESO LORDO [Kg]: 4,260  
/ GROSS WEIGHT [Kg]:

MATERIALI:  
/ MATERIALS:

Riflettore: Rame  
/ Reflector: / Copper

Diffusore: Vetro temperato  
/ Diffusers: / Tempered glass

Braccio: Ottone  
/ Arm: / Brass

FINITURE:  
/ FINISHES:

Rame e ottone anticati  
/ Aged copper and brass