

FATE con contrappeso/*with counterweight*



LF1/SALCER/MIX/...

Saliscendi Linea FATE con portalampane e contrappeso entrambi in ceramica, carrucola in ottone anticato e con cavo pvc trasparente lunghezza 3 mt. Il saliscendi va abbinato obbligatoriamente al rosone laterale da ordinare a parte

FATE height adjustable pendant with ceramic lamp holder and counterweight, antiqued brass pulley and 3 m long transparent PVC cable. The lamp must be combined with the side rosette to be ordered separately

Aldo Bernardi s.r.l.

tel.

+39 0423 538783

Email

info@aldobernardi.it

Indirizzo / Address

via Vittorio Veneto, 7, Pieve del Grappa (TV)

DATI TECNICI: / TECHNICAL DATA:

CE IP20

SORGENTE LUMINOSA: / LIGHT SOURCE:

1x15W LED
230V - 50Hz
E27

LAMPADINA NON INCLUSA
/ LIGHT BULB NOT INCLUDED



Sorgente luminosa sostituibile dall'utente finale
/ Replaceable light source by an end-user

MATERIALE: Ceramica
/ MATERIAL: Ceramic

VOLUME [M³]: 0,02

PESO LORDO [Kg]: 2,4
/ GROSS WEIGHT [Kg]:

FINITURE:
/ FINISHES:

BL: Bianco lucido / Glossy white
BM: Bianco matt / Matte white
NL: Nero lucido / Glossy black
NM: Nero matt / Matte black
MR: Metal rame / Copper metal
PT: Platino / Platinum
AU: Oro / Gold
CU: Rame / Copper
PTMATT: Platino matt / Matte platinum
AUMATT: Oro matt / Matte gold
CUMATT: Rame matt / Matte copper

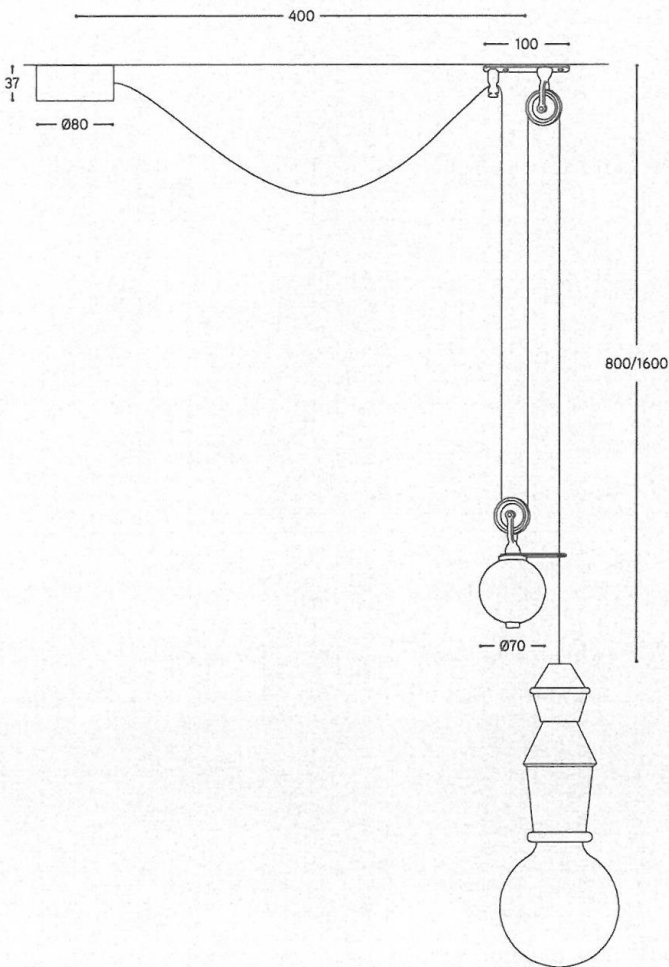

STAFFA CARRUCOLA/PULLEY BRACKET

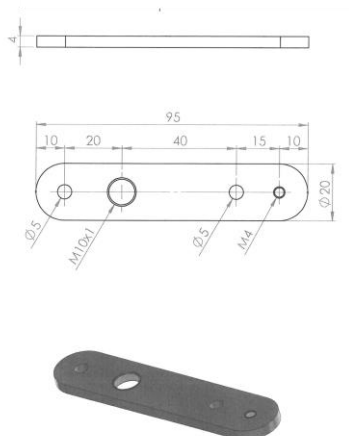

ROSONE LATERALE/LATERAL ROSE

Art. LF/R1



- Ø80 -

Art. LF/R180



- Ø80 -

Art. LF/R3



- Ø80 -

Art. LF/R4



- Ø120 -

Art. LF/R5



- Ø120 -

LF/R1 rosone a 1 entrata laterale
rose with single lateral rose

LF/R2 rosone a 2 entrate laterali a 180°
rose with 2 180° lateral entrances

LF/R3 rosone a 3 entrate laterali
rose with 3 lateral entrances

LF/R4 rosone a 4 entrate laterali
rose with 4 lateral entrances

LF/R5 rosone a 5 entrate laterali
rose with 5 lateral entrances